

High / Low Temp LCD Modules

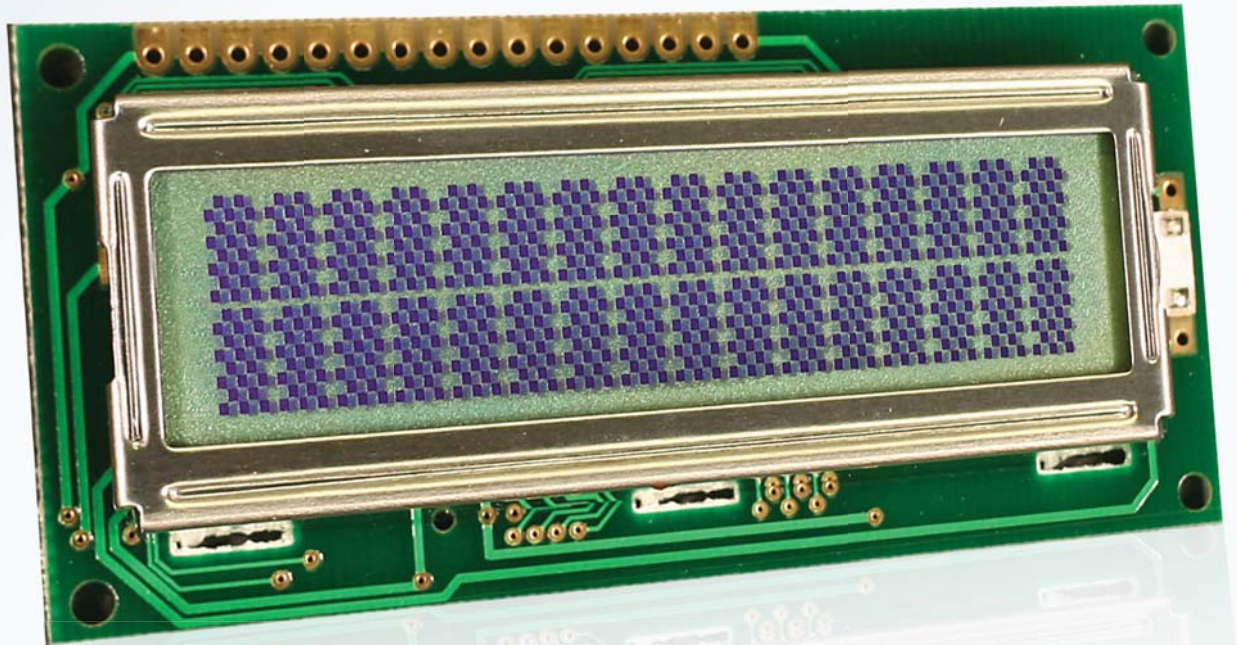

Go "Extreme" with Lumex's InfoVue™ High / Low Temp LCD Design Technology

High/Low Temp Custom LCD modules are designed specifically for products required to function under the most strenuous conditions. Versus standard, off-the-shelf LCD modules, Lumex's unique LCD design capability for High/Low Temp modules provides up to a 50% saving in technology costs and 70-80% power reduction over other traditional display technologies. Lumex's High / Low Temp LCD Modules are ideal for OEM designers that require consistent display performance despite extreme heat or extreme cold conditions.

Features:

- Offering temperature ranges from -40°C* to +85°C, with consistent cold and hot start LCD performance
- Provides high-resolution, high-duty daylight visibility
- Available from 8x1 character display up to a 320x240 graphic display
- Wide variety of color choices when paired with LED backlights
- Available in either positive or negative image display

Applications:

- Gas Pumps / Fuel Meters
- Freezer or oven displays
- Non-automotive transportation
- Non-climate controlled facilities

Markets:

- Industrial Controls
- Military
- Medical Devices
- Appliances

LUMEX®
Creating LED and LCD Solutions Together™

* Requires a heater that draws 15-20W of power. Input voltage can be tailored for specific application.

High / Low Temp LCD Modules



In addition to the Lumex's family of standard high/ low temp LCD modules, additional modules can be developed utilizing Lumex's High/Low Temp technology based on customer requirements. High / Low Temp LCDs can be developed in any size ranging from 8 x 1 character displays up to a 320 x 240 graphic display.

16 x 2 - LCR-U01602DSF/AWH

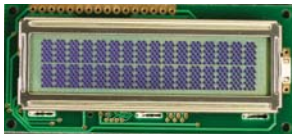

All parts come with a heater for -40°C to +85°C operation

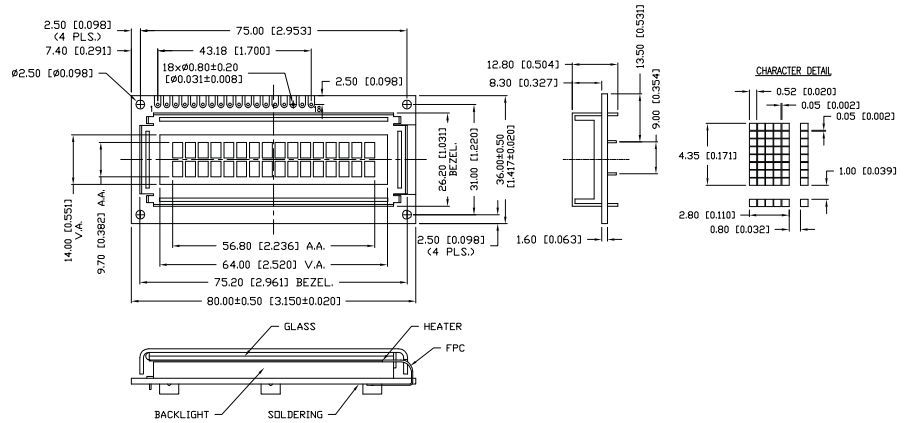

16 x 2 - LCR-U01602DSF/DWH



All parts come with a heater for -40°C to +85°C operation

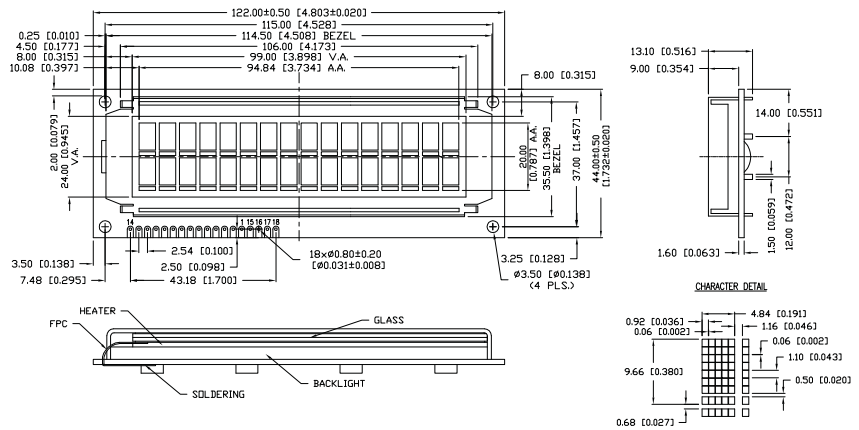

High / Low Temp LCD Modules

20 x 2 - LCR-U02002DSF-WH

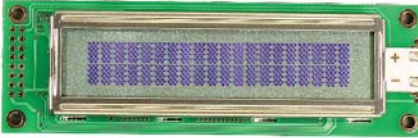

All parts come with a heater for -40°C to +85°C operation

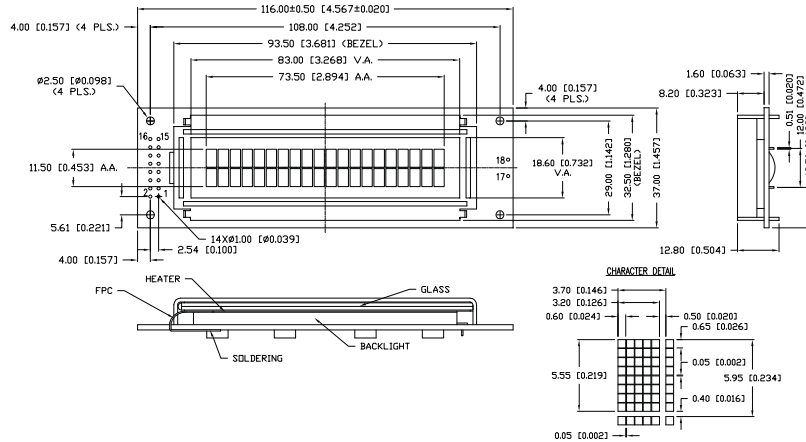

20 x 4 - LCR-U02004DSF-WH



All parts come with a heater for -40°C to +85°C operation

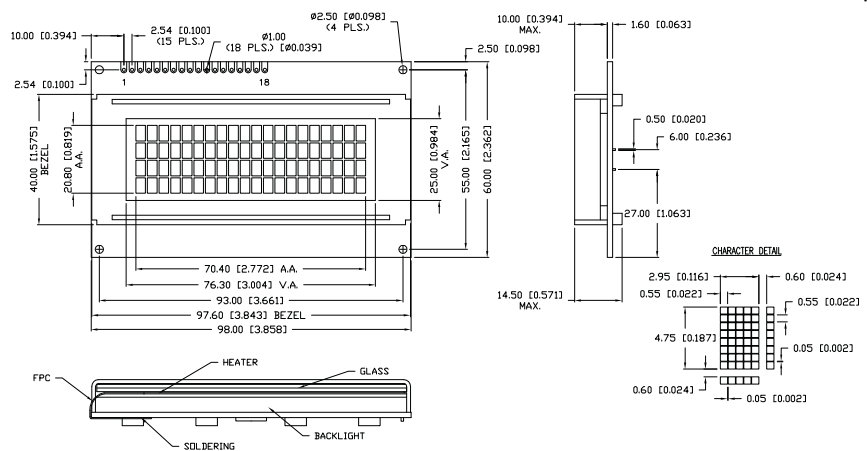

128 x 64 - LCR-U12864GSF-WH



All parts come with a heater for -40°C to +85°C operation

