

UNCONTROLLED DOCUMENT

PART NUMBER  
LDS-SMA2006RI

REV.

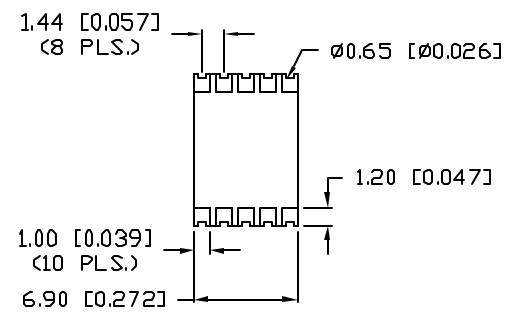
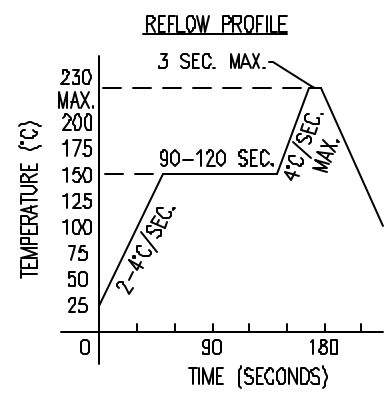
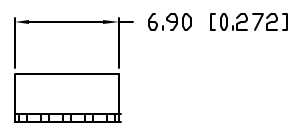
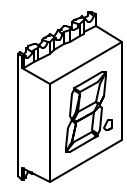
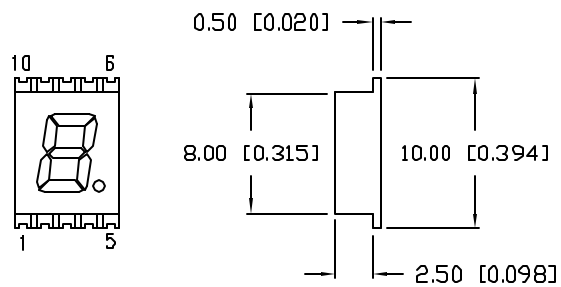

ELECTRO-OPTICAL CHARACTERISTICS  $T_A=25^\circ\text{C}$   $I_f=10\text{mA}$

PARAMETER	MIN	TYP	MAX	UNITS	TEST COND
PEAK WAVELENGTH		660		nm	
FORWARD VOLTAGE		1.7	2.2	$V_f$	
REVERSE VOLTAGE	4.0			$V_r$	$I_f=100\mu\text{A}$
AXIAL INTENSITY		6000		$\mu\text{cd}$	$I_f=10\text{mA}$
EMITTED COLOR:	RED				
FACE COLOR:	GRAY				
SEGMENT COLOR:	MILKY WHITE DIFFUSED				

LIMITS OF SAFE OPERATION AT 25°C PER SEGMENT

PARAMETER	MAX	UNITS
PEAK FORWARD CURRENT*	150	mA
STEADY CURRENT	30	mA
POWER DISSIPATION	100	mW
DERATE FROM 25°C	-1.2	mW/°C
OPERATING, STORAGE TEMP.	-40 TO +85	°C

\*  $t < 10\mu\text{s}$

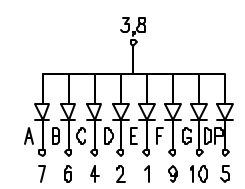
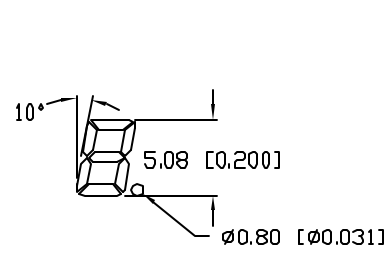
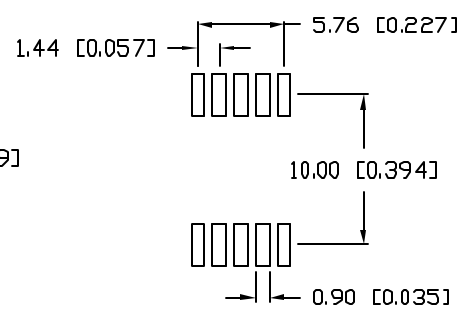
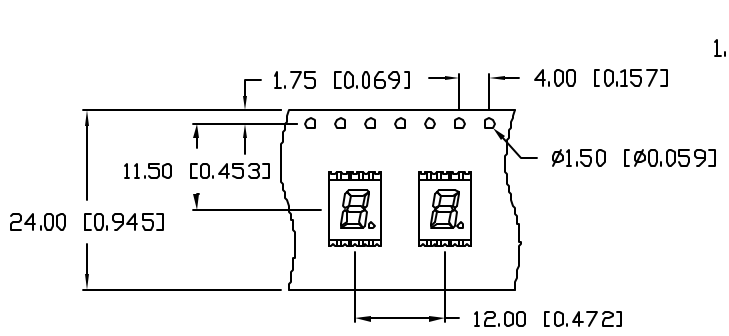

\*UNLESS OTHERWISE SPECIFIED TOLERANCES PER DECIMAL PRECISION ARE: X=±1 (±0.039), XX=±0.5 (±0.020), XXX=±0.25 (±0.010), XXXX=±0.127 (±0.005). LEAD SIZE=±0.05 (±0.002), LEAD LENGTH=±0.75 (±0.030), MIN=+0.00 DECIMAL PRECISION MAX=-0.00 DECIMAL PRECISION

UNCONTROLLED DOCUMENT

REV.	PART NUMBER
	LDS-SMA2006RI
0.20" SINGLE DIGIT, SEVEN SEGMENT, SMT LED DISPLAY, 660nm RED CHIPS, GRAY FACE WITH WHITE SEGMENTS, COMMON ANODE, 10 PADS.	

**CONFIDENTIAL INFORMATION**  
THE INFORMATION CONTAINED IN THIS DOCUMENT IS THE PROPERTY OF LUMEX INC. EXCEPT AS SPECIFICALLY AUTHORIZED IN WRITING BY LUMEX INC, THE HOLDER OF THIS DOCUMENT SHALL KEEP ALL INFORMATION CONTAINED HEREIN CONFIDENTIAL AND SHALL PROTECT SAME IN WHOLE OR IN PART FROM DISCLOSURE AND DISSEMINATION TO ALL THIRD PARTIES.

**RELIABILITY NOTE**  
OUR MANY YEARS OF EXPERIENCE DATA ACCUMULATION INDICATE THAT SOLDER HEAT IS A MAJOR CAUSE OF EARLY AND FUTURE FAILURE. PLEASE PAY ATTENTION TO YOUR SOLDERING PROCESS.

		290 E. HELEN ROAD PALATINE, IL 60067-6976 PHONE: +1.847.359.2790 US WEB: www.lumex.com TW WEB: www.lumex.com.tw	
DRAWN BY:	CHECKED BY:	APPROVED BY:	DATE: 8.11.03
BC			PAGE: 1 OF 1
			SCALE: N/A